

Turmdrehkran

80 EL 6

Tower Crane / Grue à tour / Gru a torre
Grúa torre / Guindaste de torre

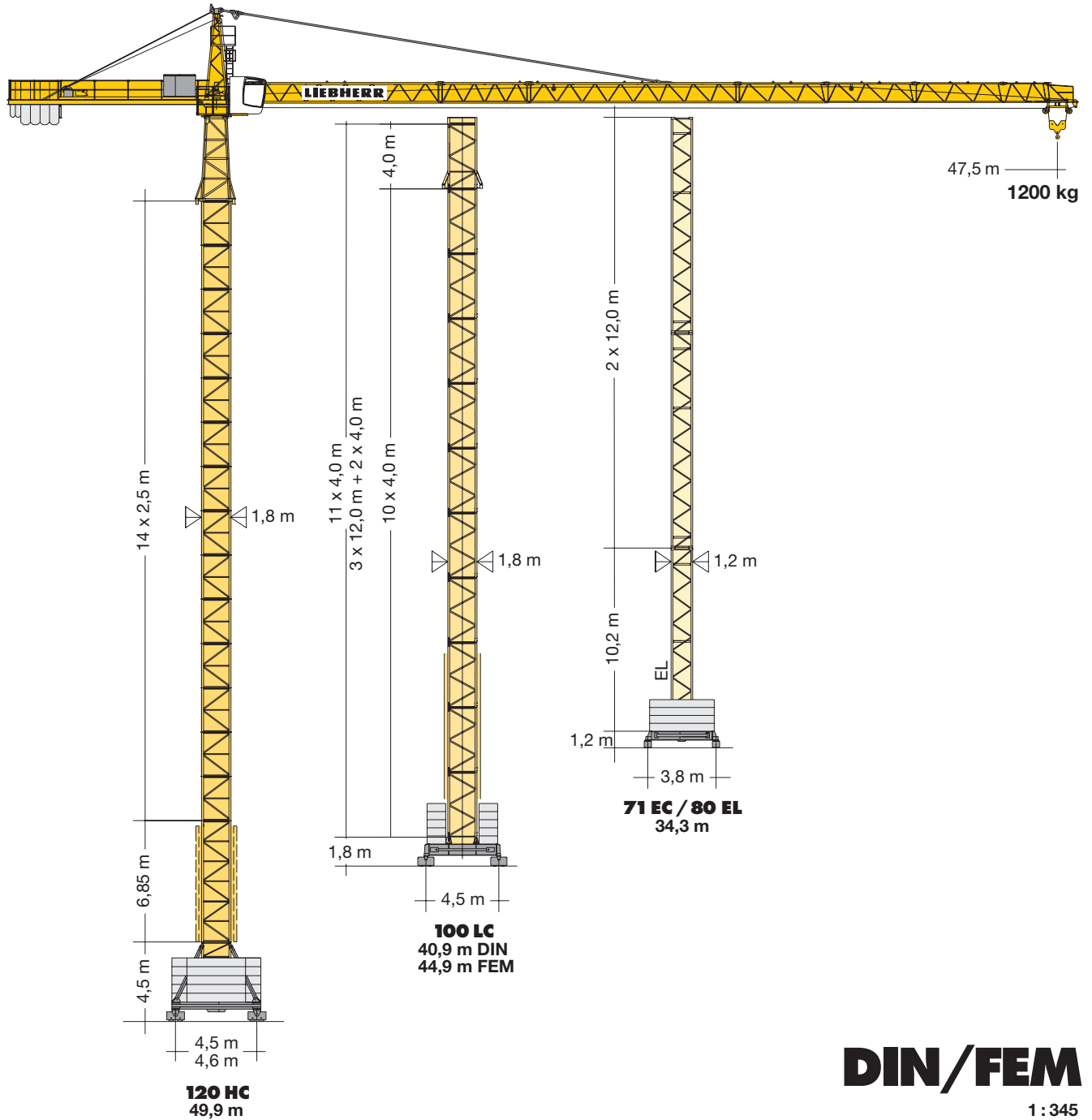

LIEBHERR

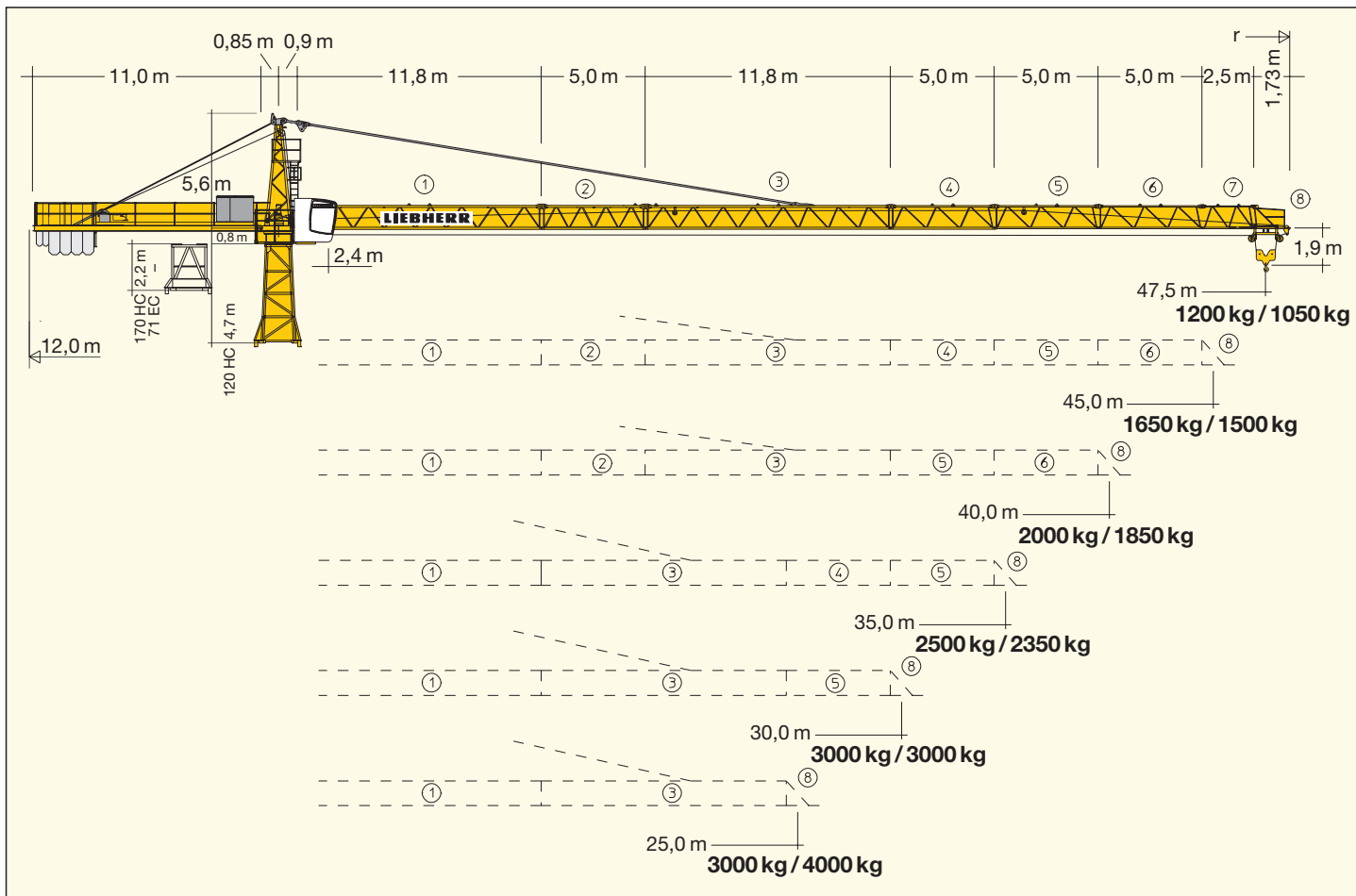



Hubhöhe







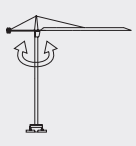

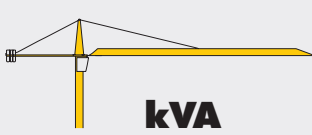

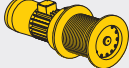
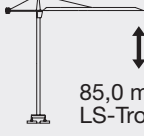





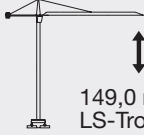





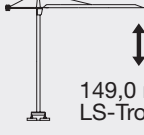

Hoisting height / Hauteur sous crochet / Altezza di sollevamento / Altura bajo gancho / Altura de montagem

	120 HC		100 LC	
14	45,6*	49,9*	-	-
13	43,1	47,4	-	-
12	40,6	44,9	-	-
11	38,1	42,4	44,9* FEM	45,0* FEM
10	35,6	39,9	40,9* DIN	41,0* DIN
9	33,1	37,4	36,9	37,0
8	30,6	34,9	32,9	33,0
7	28,1	32,4	28,9	29,0
6	25,6	29,9	24,9	25,0
5	23,1	27,4	20,9	21,0
4	20,6	24,9	16,9	17,0
3	18,1	22,4	12,9	13,0
2	15,6	19,9	8,9	9,0
1	13,1	17,4	4,9	5,0
0	10,6	14,9	-	-
	m	m	m	m

--	--	--	--

* Weitere Hubhöhen sowie Klettern im Gebäude auf Anfrage. / Further hoist heights and climbing in the building on request.
 Hauteurs sous crochet plus élevées et hissage dans le bâtiment sur demande. / Altre altezze di sollevamento come pure varianti di gru allungabili: su richiesta. / Para alturas bajo gancho superiores y trepado en el interior del edificio, consultar. / Outras alturas de elevação e subida no edifício: conforme ao pedido.

	U/min 0 - 0,8 sl./min tr./min	1 x 6,3 kW				
	12,0 / 43,0 / 85,0 m/min	0,75 / 2,4 / 3,0 kW				
	25,0 m/min	2 x 4,0 kW				
	kVA	<table border="1"> <tr> <td>22,0 kW</td> <td>22,0 kW FU</td> </tr> <tr> <td>40,0</td> <td>30,0</td> </tr> </table>	22,0 kW	22,0 kW FU	40,0	30,0
22,0 kW	22,0 kW FU					
40,0	30,0					

		Stufe / Step / Cran Marcia / Grado Velocidade		kg	m/min		
22,0 / 18,5 / 3,8 kW KL WIW 230 MZ 402							
	3 Lagen Layers Couches Strati Camadas Capas	1		3000		3000	6,0
		2		3000		3000	27,0
		3		1800		1700	56,0
85,0 m LS-Trommel							
	5 Lagen Layers Couches Strati Camadas Capas	1		3000		3000	6,2
		2		3000		3000	28,0
		3		1700		1600	58,0
149,0 m LS-Trommel							
22,0 kW FU WIW 230 MZ 404							
	5 Lagen Layers Couches Strati Camadas Capas	1		3000		3000	3,1
		2		3000		3000	31,0
		3		2400		2250	43,0
		4		1500		1350	70,0
149,0 m LS-Trommel							
		1		6000		6000	1,5
		2		6000		6000	15,0
		3		4800		4800	22,0
		4		3000		3000	35,0

Hubhöhe

Hoisting height / Hauteur sous crochet / Altezza di sollevamento / Altura bajo gancho / Altura de montagem

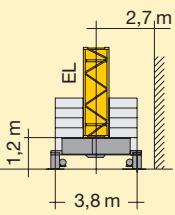
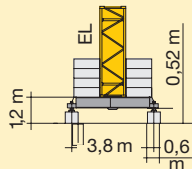
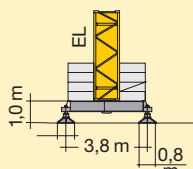
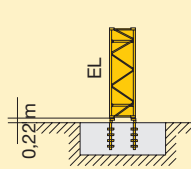
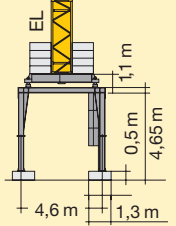
		71 EC / 80 EL				
6 m	12 m					
5			40,3	40,1	39,3	45,1
4	2	34,3	34,3	34,1	33,3	39,1
3		28,3	28,3	28,1	27,3	33,1
2	1	22,3	22,3	22,1	21,3	27,1
1		16,3	16,3	16,1	15,3	21,1
0		10,3	10,3	10,1	9,3	15,1
		m	m	m	m	m
						







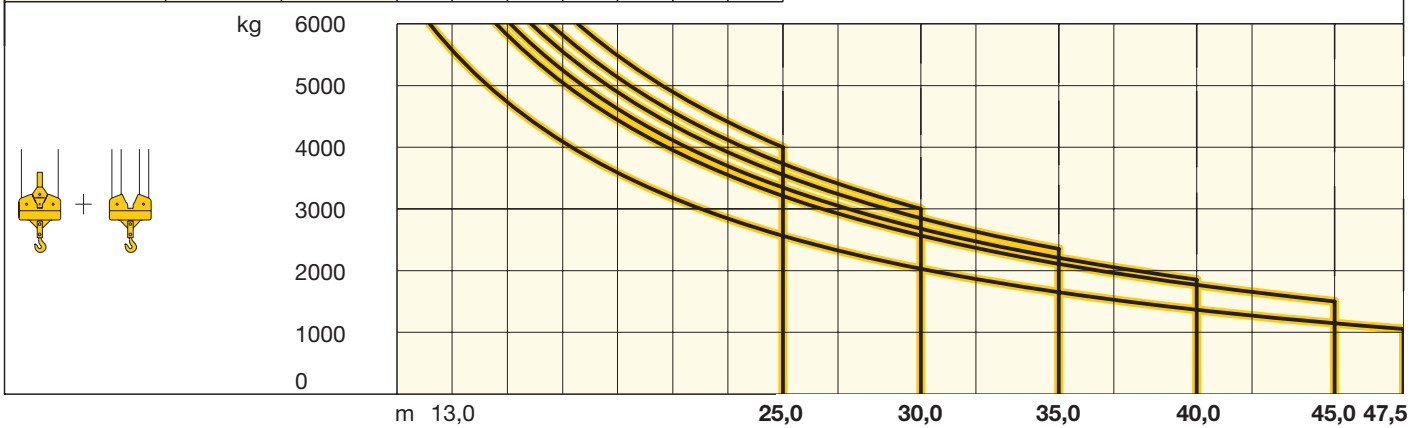

Ausladung und Tragfähigkeit

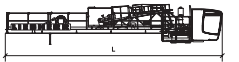

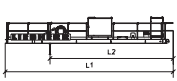
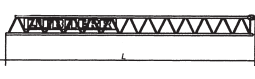

Radius and capacity / Portée et charge / Sbraccio e portata / Alcances y cargas / Alcance e capacidade de carga

m	r	m/kg	m/kg															
			13,0	15,0	17,0	19,0	21,0	23,0	25,0	27,0	30,0	32,0	35,0	37,0	40,0	42,0	45,0	47,5
47,5	(r = 49,0)	2,4-22,4 3000					3000	2910	2650	2420	2140	1980	1770	1660	1500	1410	1290	1200
45,0	(r = 46,5)	2,4-27,2 3000					3000	3000	3000	3000	2680	2490	2240	2100	1910	1800	1650	
40,0	(r = 41,5)	2,4-28,2 3000					3000	3000	3000	3000	2800	2600	2340	2200	2000			
35,0	(r = 36,5)	2,4-29,9 3000					3000	3000	3000	3000	2980	2770	2500					
30,0	(r = 31,5)	2,4-30,0 3000					3000	3000	3000	3000	3000							
25,0	(r = 26,5)	2,4-25,0 3000					3000	3000	3000									

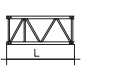
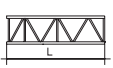
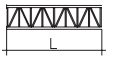
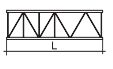
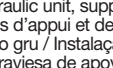
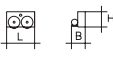
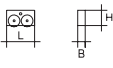
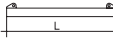
m	r	m/kg	m/kg																
			13,0	15,0	17,0	19,0	21,0	23,0	25,0	27,0	30,0	32,0	35,0	37,0	40,0	42,0	45,0	47,5	
47,5	(r = 49,0)	2,4-21,5 3000	2,4-12,2 6000	5580	4730	4090	3580	3180	2840	2560	2330	2030	1860	1650	1530	1360	1270	1140	1050
45,0	(r = 46,5)	2,4-26,0 3000	2,4-14,6 6000	6000	5820	5050	4440	3950	3550	3210	2920	2570	2370	2110	1960	1770	1650	1500	
40,0	(r = 41,5)	2,4-27,1 3000	2,4-15,1 6000	6000	6000	5250	4620	4110	3700	3350	3050	2680	2470	2210	2050	1850			
35,0	(r = 36,5)	2,4-28,6 3000	2,4-15,9 6000	6000	6000	5550	4890	4360	3920	3550	3240	2850	2630	2350					
30,0	(r = 31,5)	2,4-30,0 3000	2,4-16,6 6000	6000	6000	5820	5130	4570	4120	2730	3410	3000							
25,0	(r = 26,5)	2,4-25,0 3000	2,4-17,6 6000	6000	6000	6000	5480	4890	4410	4000									

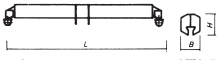
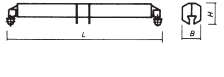
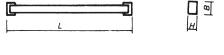

Kranoberteil		Upper part of crane / Partie supérieure de grue / Parte superiore della gru		L (m)	B (m)	H (m)	kg*	
Pos. Item	Anz. Qty.							
1	1	Komplettkrankopf / One-piece machine deck / Tête de grue Testa completa della gru Módulo giratorio / Cabeça compl. de guindaste		14,60	2,44	2,62	7700	
				12,80				
2	1	Kabine mit Podest / Cabin with platform / Cabine avec plate-forme Cabina con piattaforma / Cabina con plataforma / Cabina com plataforma		4,20	1,35	2,20	950	
3	1	Übergangsstück / Adapter section Tronçon de conversation / Spezzone collegamento / Tramo de adaptación Peça ligadora		120 HC	5,00	2,20	2,30	2540
4	1	Drehbühne kpl. / Slewing platform cpl. Ensemble mât cabine cpl. / Piattaforma girevole compl. / Conjunto plataforma de giro / Plataforma giratória compl.		2,05	1,75	2,45	2550	
5	1	Turm spitze + Teilabspannung / Tower head section + first suspension bars / Porte-flèche + premiers tirants / Cuspide + tiranti / Cabeza de torre + tirante de fijación / Cabeça de torre + parte de acessórios de ancoragem		5,30	1,40	1,70	1000	
6	1	Gegenausleger kpl. mit Ballastrahmen Counter-jib cpl. with ballast frame / Contre-flèche cpl. avec cadre de lest / Contro-freccia con telaio di contrappeso / Conjunto plataforma con bastidor contrapeso / Contra-lança compl. com quadro de contrapeso		L1 11,10	2,00	2,55	3450	
7	1	Ausleger-Anlenkstück + Teilabspannung Jib heel section + first suspension bars Pied de flèche + premiers tirants / 1 Elemento freccia + tiranti parziale / Tramo pie de pluma + Tirante de fijación / Base articulada da lança + parte de acessórios de ancoragem		11,97	1,15	1,50	① 1600	
8	1	Ausleger-Zwischenstück + Abspannung Intermediate jib section + suspension bars Elément interm. de flèche + tirants / Elementi intermedi braccio + tiranti / Tramo intermedio de pluma + tirantes / Peça suplementar de lança + acessórios de ancoragem		5,20	1,02	1,50	② 590	
				12,00	1,02	1,50	③ 1350	
				5,20	1,02	1,25	④ 350	
				5,20	1,02	1,25	⑤ 290	
				5,20	1,02	1,25	⑥ 220	
9	1	Ausleger-Kopfstück / Jib head Pointe de flèche / Punta freccia Cabeça de lança / Tramo punta de pluma		2,70	1,02	1,25	⑦ 120	
				1,80	1,02	1,40	⑧ 125	
Turm		Tower / Mât / Torre						
11		Turmstück / Tower section Element de mât / Elemento di torre Torre / Torre		71 EC	3,00	1,20	1,20	1080
				100 LC	6,00	1,20	1,20	1480
				120 HC	4,00	1,80	1,80	1210
				120 HC	2,50	1,80	1,80	1090
				120 HC	5,00	1,80	1,80	1830
12		Turmstück lang / Long tower section Elément de mât long / Elemento di torre, lungo / Tramo de torre largo / Peça de torre, comprida		71 EC	12,00	1,20	1,20	2610
				100 LC	12,00	1,80	1,80	3780
				120 HC	10,00	1,80	1,80	3425
13	1	Grundturmstück / Base tower section Mât de base / Elemento di torre base Tramo torre base / Peça de base de torre		80 EL	10,20	1,20	1,20	3300
				120 HC	6,85	1,80	1,80	2610
				120 HC	10,00	1,80	1,80	3530
Klettereinrichtung		Climbing equipment / Equipement de télescopage / Attrezzatura per allungamento della gru						
		Equipo de trepado / Acessórios p. subida no edificio						
14	1	Führungsstück kpl. / Guide section cpl. Cage télescopique cpl. / Gabbia de sopraelevazione compl. / Peça de guia compl. / Torre de montaje completa		100 LC	8,92	2,25	2,35	2180
				120 HC	6,45	2,10	2,42	2660
				120 HC	9,60	2,10	2,42	4410
15	1	Hydraulikanlage, Stütz- und Klettertraverse / Hydraulic unit, supporting and climbing cross members / Système hydraulique avec traverses d'appui et de télescopage Sistema idraulico, traversa di appoggio e allungamento gru / Instalação hidráulica, travessa de apoio e subida / Sistema hidráulico con travesa de apoyo y trepado		120 HC	2,87	2,12	1,06	1800
Unterwagen		Undercarriage / Châssis / Carro della gru						
		Carro con mástil / Carro de guindaste						
16	2	Fahrschemel mit Antrieb / Rail bogie with drive / Bogie moteur / Telaio con gruppo propulsore / Quadro sem grupo de propulsão / Caja rodillo motriz		71 EC	0,75	0,55	0,55	307
				100 LC	1,07	0,52	0,65	460
				120 HC	1,38	0,88	0,87	900
17	2	Fahrschemel ohne Antrieb / Rail bogie without drive / Bogie fou / Telaio senza gruppo propulsore / Quadro com grupo de propulsão / Caja rodillo conducido		71 EC	0,65	0,30	0,55	222
				100 LC	1,07	0,25	0,65	380
				120 HC	1,17	0,60	0,87	860
18	1	Tragholm I / Arm I Longeron I / Longherone I Travessa I / Brazo I		100 LC	6,66	0,71	0,75	2110
				120 HC	7,12	0,75	0,65	950

Pos. Item Rep. Voce Pos. Ref.	Anz. Qty. Qté. Qta. Cant. Cant.				L (m)	B (m)	H (m)	kg*	
19	2	Tragholm II / Arm II Longeron II / Longherone II Travessa II / Brazo II		100 LC 120 HC	6,66 3,45	0,78 0,56	0,75 0,55	2330 408	
20	4 2 + 2	Randträger / Border support Traverse / Supporti base Traviesa / Apoio de bordo		120 HC	4,02	0,35	0,12	95	
21	4	Stützholm / Support strut Hauban de châssis / Correnti di appoggio Tirante vertical / Travessa de apoio		120 HC	3,78	0,15	0,22	200	
22	1	Unterwagen-Turmstück / Undercarriage tower section / Mât de châssis / Elemento di torre del carro / Tramo de carro / Peça de torre do chassis		120 HC	3,50	2,06	2,06	1320	
23	2	Fundamentkreuz mit Spindeln, Tragholm lang Cruciform base with outrigger jacks, long support arm / Châssis en croix avec vérins, longeron long Base incrociata con aste, longherone lungo Tramo largo base cruciforme, con husillos / Base cruciforme com árvores, travessa comprida		80 EL	3,80 m	5,80	0,60	0,80	1860
24	2	Fundamentkreuz fahrbar, Tragholm lang Cruciform rail going, long support arm / Châssis en croix roulant, longeron long / Base incrociata mobile, longherone lungo / Brazo soporte largo de base cruciforme para traslación sobre via Base cruciforme móvel, travessa comprida		80 EL	3,80 m	5,60	0,60	0,90	1750
25	4	Fundamentkreuz fahrbar, Randträger Cruciform rail going, border support / Châssis en croix roulant, traverse / Base incrociata mobile, traversa / Traviesa de base cruciforme Base cruciforme móvel, apoio de bordo (Fahrwerke wie Pos. 16 und 17) / (Travel gears as under item 16 and 17) / (Mécanismes de translation comme pos. 16 et 17) / (Gruppi propulsori marcia come da voce 16 e 17) / (Mecanismos de traslación como Pos. 16 y 17) / (Grupos de propulsão de marcha: igual a ref. 16 et 17)		80 EL	3,80 m	3,40	0,20	0,35	114
26	1	Kiste mit Kleinteilen / Crate with small parts Caisse contenant des accessoires / Cassa con accessori Caja con accesorios / Caixa de acessórios		120 HC	2,00	1,00	1,00	2000	

* **Einzelgewichte.** / Single weights. / Poids individuels. / Pesì di componenti. / Pesos de peças componentes. / Pesos unitarios.

Konstruktionsänderungen vorbehalten!

Subject to alterations! / Sous réserves de modifications!
Si fa riserva di modifiche! / Salvo modificação da construação!
¡Sujeto a modificaciones!

Sämtliche Angaben erfolgen ohne Gewähr. / This information is supplied without liability.

Ces renseignements sont sans garantie. / Le indicazioni contenute si intendono salvo errori ed omissioni.
Declinamos toda responsabilidad derivada de la información proporcionada. / Declinamos qualquer
responsabilidade quanto à informação fornecida.