

**Tower Crane
Grue à tour**

Turmdrehkran 40 K

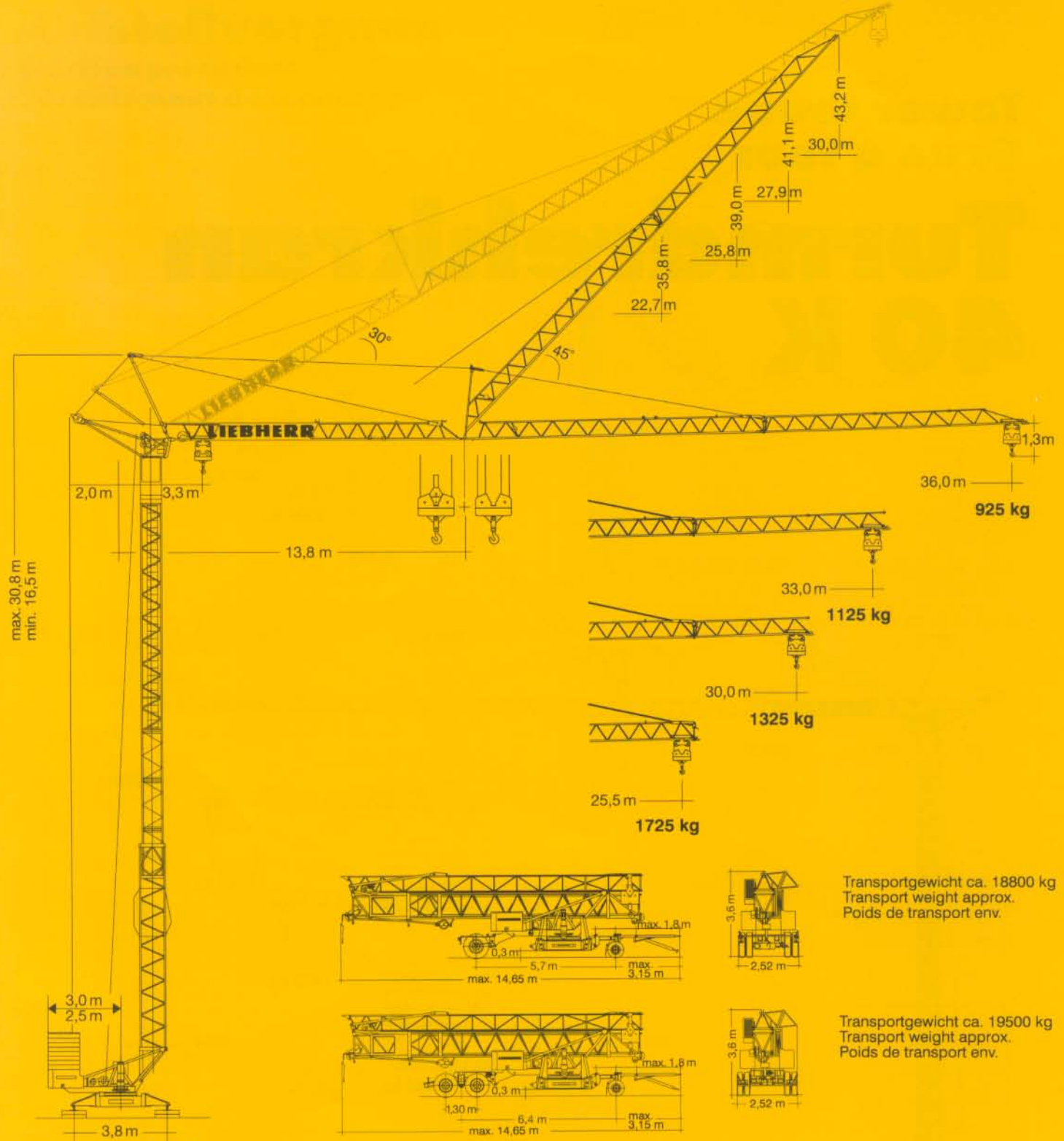

LIEBHERR



Gewicht

Weight

Poids

Zentralballast Central ballast weight Lest de base		1400 kg	Konstruktionsgewicht ca. Dead weight approx. Poids de la construction env.	10360 kg (bei max. HH 26 m: + 900 kg)
Gegengewicht Counterweight Contrepoids	r = 3,0 m r = 2,5 m	22440 kg 26360 kg		

40 K

Ausladung und Tragfähigkeit

Radius and capacity / Portée et charge



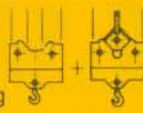

Auslegerlänge Length of jib Longueur de flèche m	max. kg m/kg		m/kg																		
			19,0	20,0	21,0	22,0	23,0	24,0	25,0	25,5	26,0	27,0	28,0	29,0	30,0	31,0	32,0	33,0	34,0	35,0	36,0
36,0	3,3 - 19,8 2075																				
33,0	3,3 - 20,9 2075																				
30,0	3,3 - 21,6 2075																				
25,5	3,3 - 22,6 2075																				

m	max. kg m/kg		m/kg																					
			10,0	11,0	12,0	13,0	14,0	16,0	18,0	20,0	22,0	24,0	25,5	26,0	27,0	28,0	29,0	30,0	31,0	32,0	33,0	34,0	35,0	36,0
36,0	3,3 - 11,4 4000	- 19,8 2000	4000	4000	3745	3385	3080	2605	2250	1975	1750	1570	1450	1415	1350	1290	1230	1180	1130	1085	1040	1000	960	925
33,0	3,3 - 12,0 4000	- 20,9 2000	4000	4000	4000	3625	3300	2795	2415	2120	1885	1690	1565	1525	1455	1390	1330	1275	1220	1170	1125			
30,0	3,3 - 12,4 4000	- 21,6 2000	4000	4000	4000	3755	3425	2900	2505	2200	1955	1755	1625	1590	1515	1445	1385	1325						
25,5	3,3 - 12,9 4000	- 22,6 2000	4000	4000	4000	3965	3615	3065	2650	2330	2070	1860	1725											

m	max. kg m/kg		Auslegersteilstellung 30° Elevated jib 30° Flèche inclinée 30° m/kg																				
			14,0	15,0	16,0	17,0	18,0	19,0	20,0	21,0	22,3	23,0	24,0	25,0	26,2	27,0	28,0	28,8	30,0	31,0	31,4		
36,0	3,3 - 14,7 2075		2075	2030	1875	1740	1620	1510	1420	1340	1240	1190	1130	1070	1010	970	930	895	850	810	800		
33,0	3,3 - 16,0 2075		2075	2075	2075	1925	1790	1680	1570	1480	1380	1330	1260	1190	1130	1080	1040	1000					
30,0	3,3 - 17,3 2075		2075	2075	2075	2075	1980	1850	1740	1640	1520	1470	1390	1320	1250								
25,5	3,3 - 18,0 2075		2075	2075	2075	2075	2075	1940	1830	1720	1600												

Geschwindigkeiten

Speeds / Vitesses

	0 ↔ 0,9 U/min sl./min tr./min	3,0 kW, EDC
	20,0 / 40,0 m/min	1,3 / 2,3 kW
	25,0 m/min	2 x 1,3 kW
	0-45° ca. 30 sec.	4,0 kW

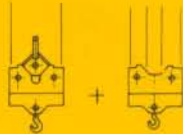
Hubwerk Hoist unit Mécanisme de levage	Stufe Step Cran	kg	m/min
	1	2075	6,0
	2	2075	25,0
	3	1000	50,0
	1	2000 4000	6,0 3,0
	2	2000 4000	25,0 12,5
	3	1000 2000	50,0 25,0

Leitungsquerschnitt bei 380 V bis 63,0 m 4 x 10 mm²
Cross section of cable up to
Section de câble à jusqu'à

Betriebsspannung 380 V
Operating voltage
Tension de service

Frequenz 50 Hz
Frequency
Fréquence

Anschlußwert 21,0 kVA
Power requirement
Puissance requise

Technische Kenngröße nach BGL

Technical nominal size according to the construction machinery list (BGL)
Grandeur caractéristique suivant le barème d'emploi des appareils (BGL)



2108-0040



2108-0040

Technische Daten - Technical data

Caractéristiques techniques

Aufstellvorgang

Erection procedure

Déroulement de montage

Ballasterausladung 5,0 m

Ballasting radius 5,0 m



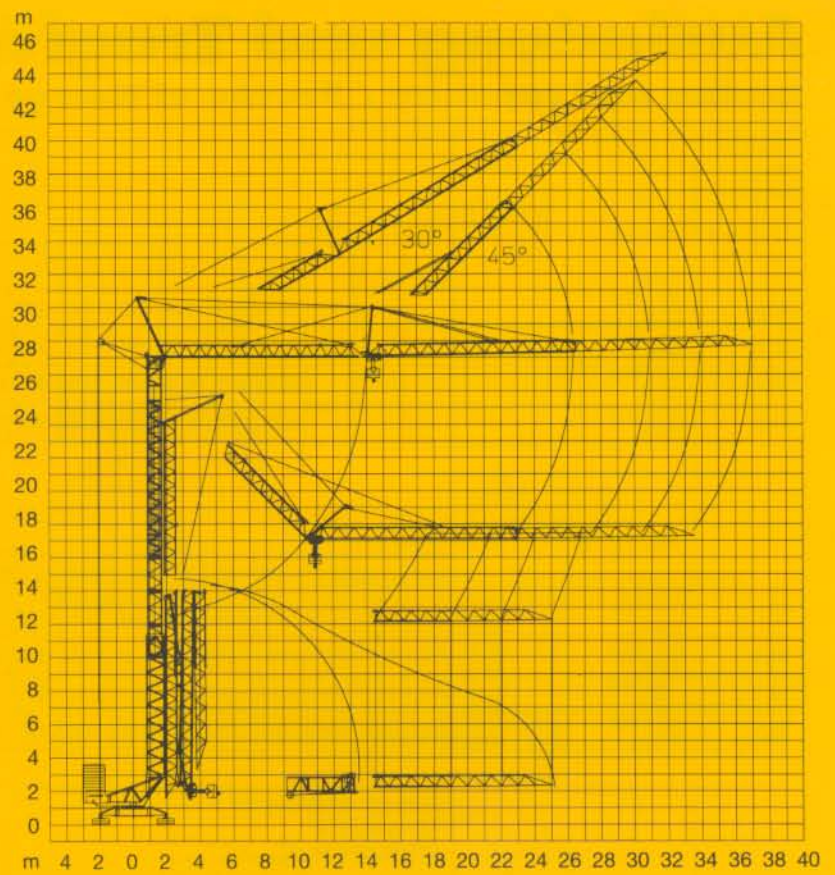











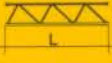

Portée pour dispositif de lestage 5,0 m



Kolli-Liste

Packing List

Liste de colisage

Pos. Item Rep.	Anz. Qty Qté	Turmstück Tower section Élément de mât			L (m)	B (m)	H (m)	kg
1	3	Turmstück Tower section Élément de mât			2,10	0,85	0,88	350
2	1	Ausleger-Verlängerung 25,5 m – 30,0 m Jib extension Rallonge de la flèche			4,70	0,80	0,70	180
3	1	Ausleger-Verlängerung 30,0 m – 33,0 m Jib extension Rallonge de la flèche			3,10	0,80	0,70	110
4	1	Ausleger-Verlängerung 33,0 m – 36,0 m Jib extension Rallonge de la flèche			3,10	0,80	0,70	95
5	1	Transportachse vorne Tra 100 KY 1 Road transport axle front Essieux de transport avant			3,00	1,13	0,97	660
6	1	Transportachse hinten Tra 120 GY 1A Road transport axle behind Essieux de transport arrière			1,90	2,50	1,05	1150
7	1	Transportachse Tra 200 GZ 3 Road transport axle Essieux de transport			3,10	2,50	1,10	2600
8	1	Kiste mit Seilen und Kleinteilen Case with ropes and small parts Caisse avec câbles et pièces détachées			1,00	0,80	1,00	450

Datenblatt Nr. 120 P – 3451 H1 B3 DIN 15018 • BGL 2108-0040 /
FEM (Section 1) Krangruppe A3 und OENORM T3 • 04.95

Data sheet

Feuille de caractéristiques

Konstruktionsänderungen vorbehalten!
Subject to alterations!
Sous réserves de modifications!

Printed in Germany.

Nehmen Sie Kontakt auf mit
Please contact

Mettez-vous en rapport avec

LIEBHERR-WERK BIBERACH GMBH, Postfach 1663, D-88396 Biberach an der Riß

☎ (0 73 51) 41-0, Fax (0 73 51) 4 12 25