

**Tower Crane / Grue à tour / Gru a torre
Grúa torre / Guindaste de torre**

Turmdrehkran 112 EC-B 8

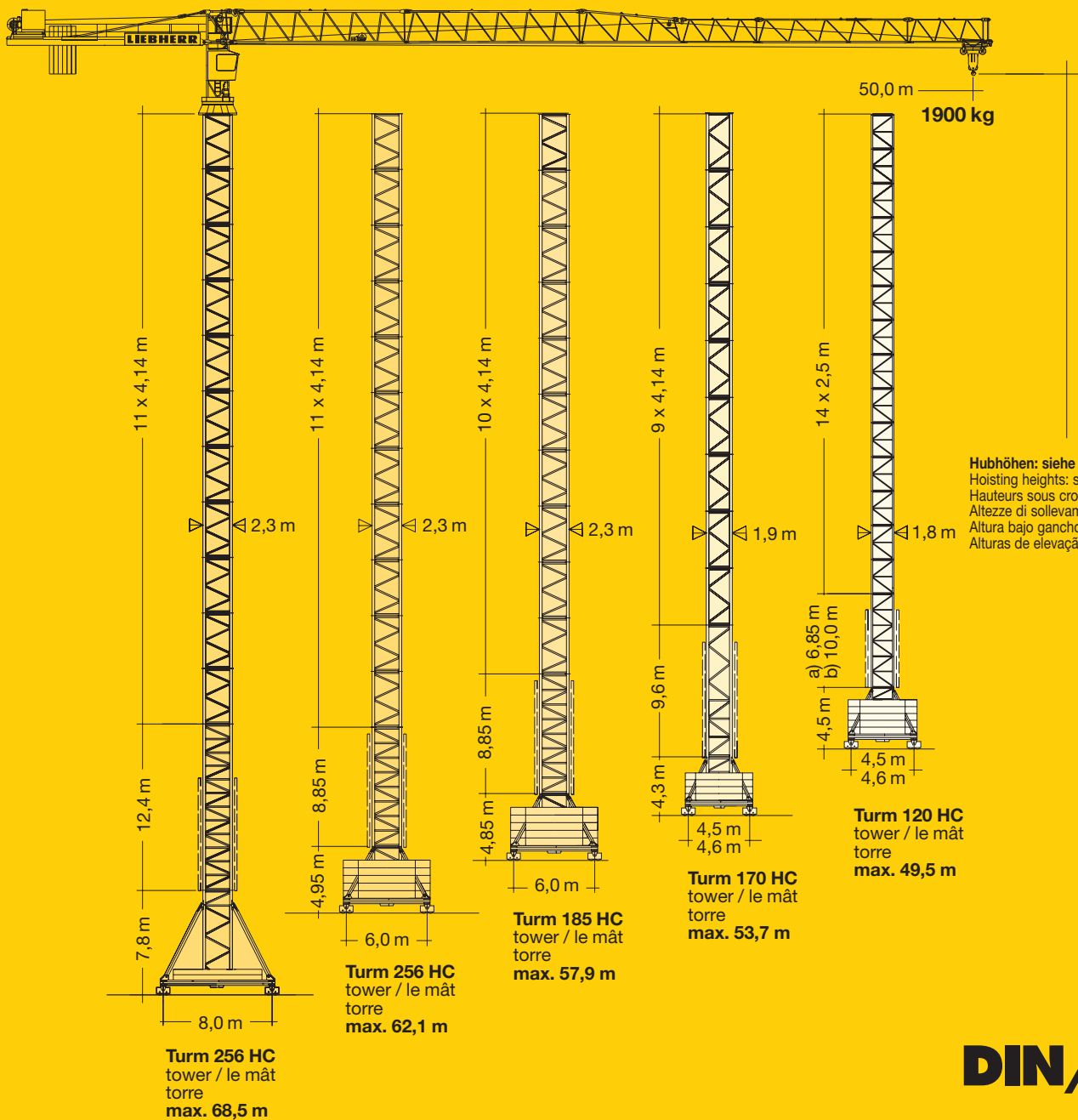

DIN/FEM

1 : 480

LIEBHERR

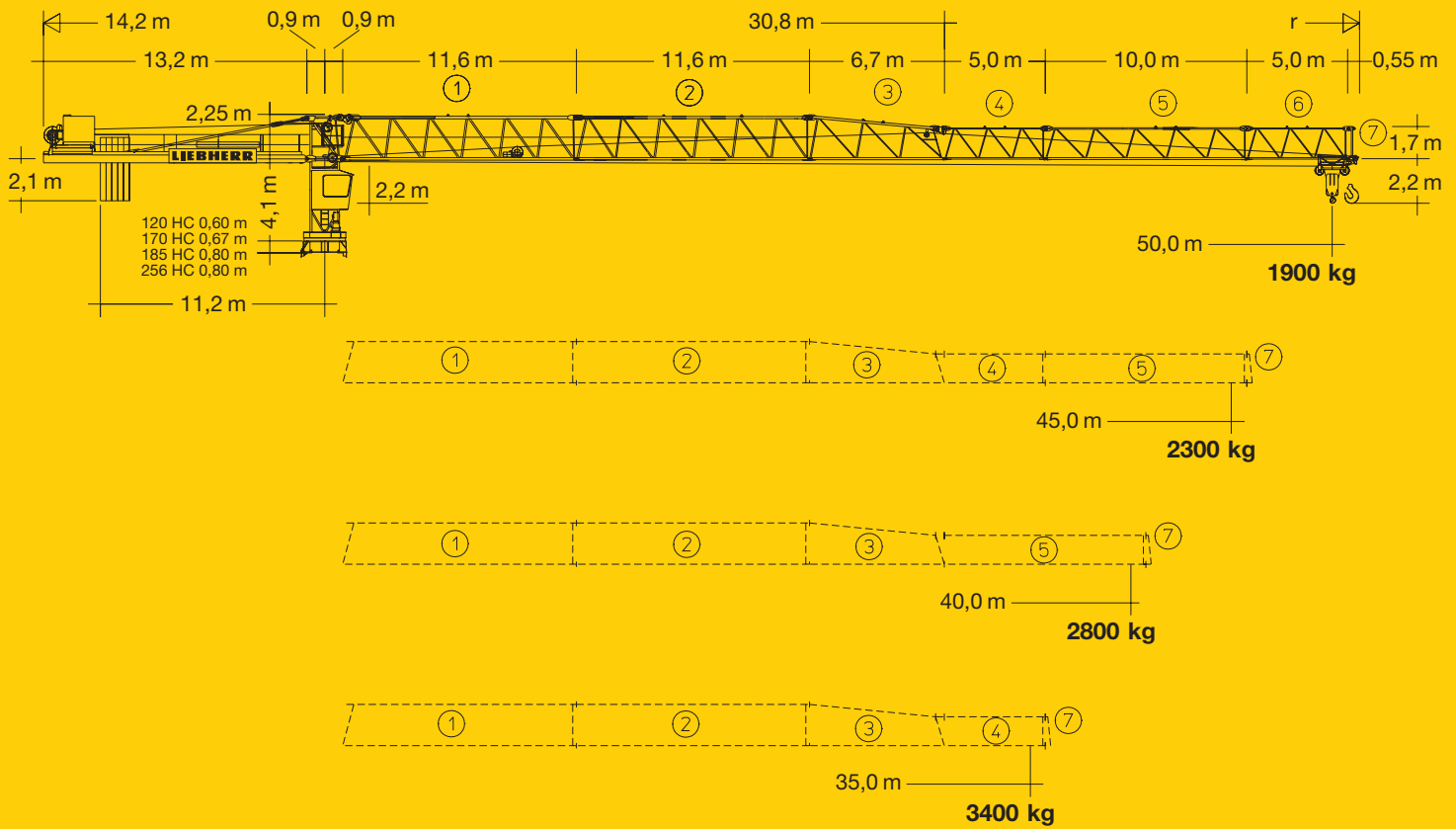

Hubhöhe

Hoisting height / Hauteur sous crochet / Altezza di sollevamento / Altura bajo gancho / Altura de montagem

		120 HC															
15	m	-		-		m 47,1*		-		-		-		-		-	
		14	48,9*	-	48,4*	-	42,1	44,6*	-	-	-	-	47,3*	-	46,8*	-	44,3
13	46,4	49,5*	45,9	49,0*	42,1	45,2*	45,2*	-	-	-	44,8	-	44,3	-	44,3	-	
12	43,9	47,0*	42,4	46,5	39,6	42,7*	41,1*	44,2*	43,4*	-	40,9*	44,0*	42,3	45,4*	41,8	44,9*	
11	41,4	44,5	40,9	44,0	37,1	40,2	38,6	41,7*	38,4	41,5*	39,8	42,9	39,3	42,4	39,3	42,4	
10	38,9	42,0	38,4	41,5	34,6	37,7	36,1	39,2	35,9	39,0	37,3	40,4	36,8	39,9	36,8	39,9	
9	36,4	39,5	35,9	39,0	32,1	35,2	33,6	36,7	33,4	36,5	34,8	37,9	34,3	37,4	34,3	37,4	
8	33,9	37,0	33,4	36,5	29,6	32,7	31,1	34,2	30,9	34,0	32,3	35,4	31,8	34,9	31,8	34,9	
7	31,4	34,5	30,9	34,0	27,1	30,2	28,6	31,7	28,4	31,5	29,8	32,9	29,3	32,4	29,3	32,4	
6	28,9	32,0	28,4	31,5	24,6	27,7	26,1	29,2	25,9	29,0	27,3	30,4	26,8	29,9	26,8	29,9	
5	26,4	29,5	25,9	29,0	22,1	25,2	23,6	26,7	23,4	26,5	24,8	27,9	24,3	27,4	24,3	27,4	
4	23,9	27,0	22,4	26,5	19,6	22,7	21,1	24,2	20,9	24,0	22,3	25,4	21,8	24,9	21,8	24,9	
3	21,4	24,5	20,9	24,0	17,1	20,2	18,6	21,7	18,4	21,5	19,8	22,9	19,3	22,4	19,3	22,4	
2	18,9	22,0	18,4	21,5	14,6	17,7	16,1	19,2	15,9	19,0	17,3	20,4	16,8	19,9	16,8	19,9	
1	16,4	19,5	15,9	19,0	12,1	15,2	13,6	16,7	13,4	16,7	14,8	17,9	14,3	17,4	14,3	17,4	
0	a) 13,9	b) 17,0	a) 13,4	b) 16,5	a) 9,6	b) 12,7	a) 11,1	b) 14,2	a) 10,9	b) 14,0	a) 12,3	b) 15,4	a) 11,8	b) 14,9	a) 11,8	b) 14,9	

Unterwagen: ① fahrbar, ② stationär. ③ Fundamentanker. Fundamentkreuz: ④ fahrbar, ⑤ stationär. Unterwagen klappbar: ⑥ fahrbar, ⑦ stationär.
 Undercarriage: ① rail-going, ② stationary. ③ Foundation anchors. Cruciform base: ④ rail-going, ⑤ stationary. Hinged undercarriage: ⑥ rail-going, ⑦ stationary.
 Châssis: ① mobile, ② stationnaire. ③ Pies de scellement. Châssis en croix: ④ mobile, ⑤ stationnaire. Châssis articulé: ⑥ mobile, ⑦ stationnaire.
 Carro: ① traslante, ② stazionario. ③ Tirafondi. Crociera di fondazione: ④ traslante, ⑤ stazionario. Carro ripiegabile: ⑥ traslante, ⑦ stazionario.
 Carretón: ① móvil, ② estacionaria. ③ Pies de anclaje. Base cruciforme: ④ móvil, ⑤ estacionaria. Carretón articulado: ⑥ móvil, ⑦ estacionaria.
 Chassis: ① Móvel, ② Estacionária. ③ Pés de ancoragem. Base cruciforme: ④ Móvel, ⑤ Estacionária. Chassis articulado: ⑥ Móvel, ⑦ Estacionária.

112 EC-B 8

Ausladung und Tragfähigkeit

Radius and capacity / Portée et charge / Sbraccio e portata / Alcances y cargas / Alcance e capacidade de carga

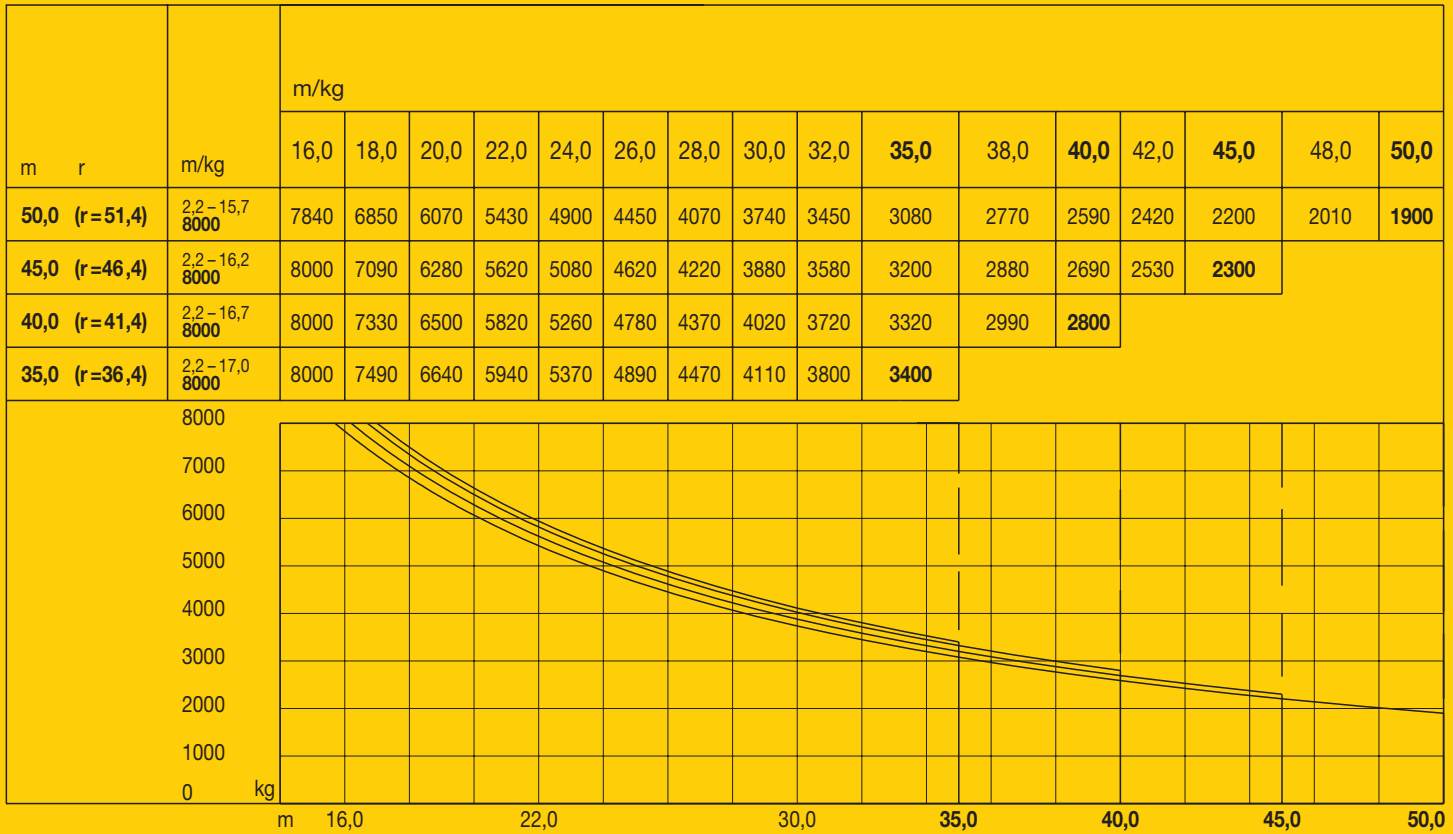



	170 HC		185 HC		256 HC	
12	-	-	-	-	-	-
11	-	-	-	-	-	-
10	53,8*	-	53,3*	-	57,4*	-
9	49,7*	-	49,2	-	49,1	-
8	45,5	53,7*	45,0	57,9*	45,0	62,1*
7	41,4	49,6*	40,9	49,6	40,8	58,0
6	37,2	45,4	36,7	45,5	36,7	53,8
5	33,1	41,3	32,6	41,3	32,6	49,7
4	29,0	37,1	28,5	37,2	28,4	45,5
3	24,8	33,0	24,3	33,0	24,3	41,4
2	20,7	28,9	20,2	28,9	20,1	37,3
1	16,5	24,7	16,0	24,8	16,0	33,1
0	12,4	20,6	11,9	20,7	11,9	29,0
	m	16,4	m	16,5	m	16,6

* Weitere Hubhöhen sowie Klettern im Gebäude auf Anfrage. / Further hoist heights and climbing in the building on request.
 Hauteurs sous crochet plus élevées et hissage dans le bâtiment sur demande. / Altre altezze di sollevamento come pure varianti di gru allungabili: su richiesta. / Para alturas bajo gancho superiores y trepado en el interior del edificio, consultar. / Outras alturas de elevação e subida no edifício: conforme ao pedido.

Geschwindigkeiten

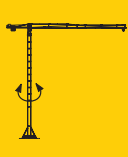
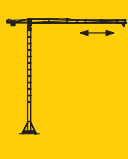
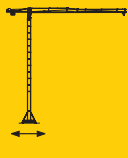
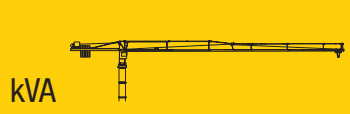
Speeds / Vitesses / Velocità / Velocidades / Velocidades

	U/min 0 ↔ 0,8 sl./min tr./min	1 x 6,3 kW
	0 ↔ 100,0 m/min	5,5 kW, FU
	25,0 m/min	2 x 3,0 kW 120 HC (132 HC) 2 x 7,5 kW 256 HC (290 HC) 2 x 5,5 kW (185 HC, 170 HC)
	kVA	 30 kW 30 kW, FU 37 kW, FU 68,0 45,0 50,0

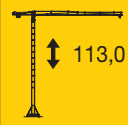
	Gang / Gear / Rapport Marcia / Velocidad Velocidade	kg	m/min
	30,0 / 25,0 / 6,2 kW, Elmag WIW 240 RX 036		
5 Lagen Layers Couches strati camadas capas			
1		8000	3,4
		8000	15,0
		4600	30,0
2		3100	8,0
		3100	36,0
		1800	71,0

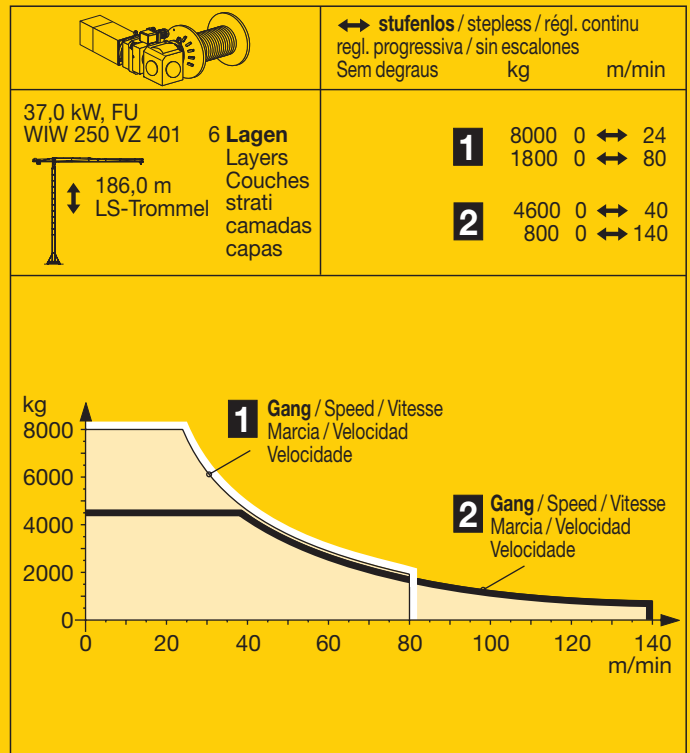
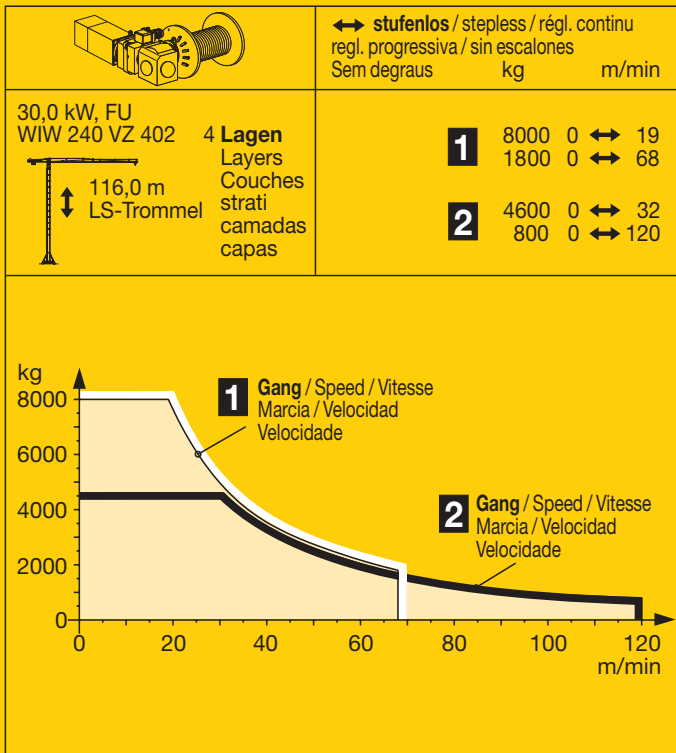

Weitere Elmag-Hubwerke: siehe Broschüre „Zusätzliche Hubwerksvarianten“ / Further hoist gears: see brochure „Additional hoist gear variants“ / Autres mécanismes de levage: voir brochure „Variantes supplémentaires du mécanisme de levage“ / Ulteriori argani ad innesto elettromagnetico: vedere prospetto „argani alternativi“ / Otros mecanismos de elevación de Elmag: Ver folleto „Mecanismos de elevación adicionales“ / Outros mecanismos de elevacao de ELMAG: Ver Folheto „Mecanismos de elevação adicionais“

Technische Daten



















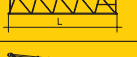

















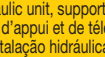

Technical data - Caractéristiques techniques

Caratteristiche tecniche - Características técnicas - Datos técnicos

Kolli-Liste

Packing List / Liste de colisage / Lista dei colli
Lista de contenido / Lista de embalagem





Montagegewichte: siehe Betriebsanweisung.
Erection weights: see instruction manual.
Poids de montage: voir manuel de service.
Pesi di montaggio: vedasi le istruzioni sull'uso.
Pesos de montagem: vejäm-se es instruções p. uso.
Peso para el montaje: según manual.

Kranoberteil		Upper part of crane / Partie supérieure de gru Parte superiore della gru / Parte superior grúa Parte superior do guindaste		L (m)	B (m)	H (m)	kg			
Pos. Item Rep. Voce Pos. Ref.	Anz. Qty. Qta. Cant. Cant.	Drehbühne kpl. / Slewing platform cpl. Ensemble mât cabine cpl. / Piattaforma girevole compl. / Conjunto plataforma de giro / Plataforma giratória compl.			120 HC (132 HC)	7,14	2,30	2,50	8300	
					170 HC					8950
					185 HC (200 HC)					9000
					256 HC (290 HC)					9000
2	1	Gegenausleger / Counter-jib Contre-flèche / Controbraccio Contrapluma / Contra-lança			13,23	2,42	0,91	3940		
3	1	Ausleger-Anlenkstück / Jib heel section Pied de flèche / Settore articolato di braccio Base articulada de lança / Pluma tramo primero			11,87	1,70	2,37	① 2870		
4	1	Ausleger-Zwischenstück / Intermediate jib section Elément interm. de flèche / Spezzone di braccio Peça suplementar da lança / Tramo intermedio pluma			11,88	1,50	2,25	② 1740		
5	1	Ausleger-Zwischenstück / Intermediate jib section Elément interm. de flèche / Spezzone di braccio Peça suplementar da lança / Tramo intermedio pluma			10,31	1,50	1,68	⑤ 730		
6	1	Ausleger-Zwischenstück / Intermediate jib section Elément interm. de flèche / Spezzone di braccio Peça suplementar da lança / Tramo intermedio pluma			6,90	1,50	2,25	③ 810		
7	2	Ausleger-Zwischenstück / Intermediate jib section Elément interm. de flèche / Spezzone di braccio Peça suplementar da lança / Tramo intermedio pluma			5,31	1,50	1,68	④ 530 ⑥ 320		
8	1	Ausleger-Kopfstück / Jib head Pointe de flèche / Punta freccia Cabeça de lança / Tramo punta de pluma			0,62	1,73	1,88	⑦ 150		
9	1	Laufkatze und Lasthaken / Trolley and hook Chariot de distribution et crochet / Carrello con gancio Carrito y gancho / Carro de ponte e gancho			1,82	1,69	1,44	860		
10	1	Hubwerkseinheit / Hoist gear unit / Treuil de levage Gruppo meccanismo sollevamento / Mecanismo de elevación / Grupo de mecanismo elevatório			2,70	2,30	1,70	2750		
11	1	Gegenausleger mit Hubwerkseinheit 45 kW Counter-jib with hoist gear unit / Contre-flèche avec treuil de levage / Controbraccio con gruppo meccanismo sollevamento / Contrapluma con mecanismo de elevación / Contra-lança com grupo de mecanismo elevatório			13,23	2,42	2,44	8300		
Turm		Tower / Mât / Torre Torre / Torre								
12	14 9 10 11	Turmstück / Tower section Element de mât / Elemento di torre Torre / Torre			120 HC (132 HC)	2,50	1,80	1,80	1050	
					170 HC	4,14	1,90	1,90	1850	
					185 HC (200 HC)	4,14	2,30	2,30	2050	
					256 HC (290 HC)	4,14	2,30	2,30	2260	
13	7 3	Turmstück lang / Long tower section Elément de mât long / Elemento di torre, lungo Tramo de torre largo / Peça de torre, comprida			120 HC (132 HC)	5,0	1,80	1,80	1960	
					120 HC (132 HC)	10,0	1,80	1,80	3400	
					120 HC (132 HC)	12,5	1,80	1,80	4200	
14	1	Grundturmstück / Base tower section Mât de base / Elemento di torre base Tramo torre base / Peça de base de torre			120 HC (132 HC)	6,85	1,80	1,80	2560	
					120 HC (132 HC)	10,00	1,80	1,80	3420	
					170 HC	9,60	1,90	1,90	4350	
					185 HC (200 HC)	8,85	2,30	2,30	4100	
					256 HC (290 HC)	8,85 (12,42)	2,30 (2,30)	2,30 (2,30)	4580 (7700)	
Klettereinrichtung		Climbing equipment / Equipement de télescope / Attrezzatura per allungamento della gru Equipo de trepado / Acessórios p. subida no edifício								
15	1	Führungsstück kpl. / Guide section cpl. / Cage télescopique cpl. / Gabbia di sopraelevazione compl. / Peça de guia compl. / Torre de montaje completa			120 HC (132 HC)	6,45	2,10	2,42	2660	
					120 HC (132 HC)	9,60	2,10	2,42	4410	
					170 HC	9,04	2,31	2,28	4750	
					185 HC (200 HC)	8,39	2,80	2,50	5100	
					256 HC (290 HC)	8,39	2,80	2,50	5100	
16	1	Hydraulikanlage, Stütz- und Klettertraverse / Hydraulic unit, supporting and climbing cross members / Système hydraulique avec traverses d'appui et de télescope / Sistema idraulico, traversa di appoggio e allungamento gru / Instalação hidráulica, travessa de apoio e subida / Sistema hidráulico con traviesa de apoyo y trepado			120 HC (132 HC)	2,87	2,12	1,06	1050	
					170 HC	2,00	1,10	1,00	1100	
					185 HC (200 HC)	2,30	1,25	1,00	1150	
					256 HC (290 HC)	2,30	1,25	1,00	1150	
Unterwagen		Undercarriage / Châssis / Carro della gru Carro con mástil / Carro de guindaste								
17	2	Fahrschemel mit Antrieb / Rail bogie with drive Bogie moteur / Telaio con gruppo propulsore Quadro sem grupo de propulsão / Caja rodillo motriz			120 HC (132 HC)	1,38	0,88	0,87	900	
					170 HC	1,46	0,84	0,87	920	
					185 HC (200 HC)	1,46	0,84	0,87	920	
					256 HC (290 HC)	1,63 (1,46)	0,92 (0,84)	0,95 (0,87)	1690 (920)	
18	2	Fahrschemel ohne Antrieb / Rail bogie without drive / Bogie fou / Telaio senza gruppo propulsore / Quadro con grupo de propulsão Caja rodillo conducido			120 HC (132 HC)	1,17	0,60	0,87	860	
					170 HC	1,15	0,60	0,87	880	
					185 HC (200 HC)	1,15	0,60	0,87	880	
					256 HC (290 HC)	1,37 (1,15)	0,62 (0,60)	0,95 (0,87)	1340 (880)	
19	1	Tragholm lang / Long support arm Longeron long / Longherone lungo Brazo largo soporte / Travessa comprida			120 HC (132 HC)	7,12	0,78	0,65	950	
					170 HC	7,15	0,80	0,70	1070	
					185 HC (200 HC)	9,10	0,82	0,74	1350	
					256 HC (290 HC)	9,10 (11,95)	0,80 (0,82)	0,80 (0,80)	1650 (2200)	

Einzelgewichte / Single weights / Poids individuels.
Pesi di componenti.
Pesos de peças componentes.
Pesos unitarios.

Pos. Anz.
Item Qty.
Rep. Qte.
Voçe Qta.
Pos. Cant.
Ref. Cant.

Einzelgewichte / Single
weights. / Poids individuels.
Pesi di componenti.
Pesos de peças componentes.
Pesos unitarios.

					L (m)	B (m)	H (m)	kg
20	2	Tragholm kurz / Short support arm Longeron court / Longherone corto Brazo corto soporte / Travessa curta		120 HC (132 HC)	3,45	0,56	0,55	408
				170 HC	3,45	0,60	0,70	500
				185 HC (200 HC)	4,41	0,62	0,71	615
				256 HC (290 HC)	4,45 (5,58)	0,77 (0,65)	0,77 (0,77)	800 (1035)
21	2 + 2	Randträger / Border support Traverse / Supporti base Traviesa / Apoio de bordo		120 HC (132 HC)	4,02	0,35	0,12	95
				170 HC	4,08 - 4,30	0,16 - 0,33	0,11 - 0,14	80 - 200
				185 HC (200 HC)	5,48 - 5,46	0,11 - 0,17	0,16 - 0,38	118 - 454
				256 HC (290 HC)	5,46 - 5,40	0,11 - 0,18	0,16 - 0,38	175 - 525
					(7,52 - 7,46)	(0,1 - 0,17)	(0,1 - 0,38)	(366 - 912)
22	4	Stützholm / Support strut Hauban de châssis / Correnti di appoggio Tirante vertical / Travessa de apoio		120 HC (132 HC)	3,78	0,15	0,22	200
				170 HC	3,53	0,25	0,17	240
				185 HC (200 HC)	4,23	0,17	0,25	275
				256 HC (290 HC)	4,14 (6,55)	0,18 (0,22)	0,25 (0,25)	320 (600)
23	1	Unterwagen-Turmstück / Undercarriage tower section / Mât de châssis / Elemento di torre del carro / Tramo de carro / Peça de torre do chassis		120 HC (132 HC)	3,50	2,06	2,06	1320
				170 HC	3,30	2,15	2,15	2000
				185 HC (200 HC)	3,73	2,52	2,52	1950
				256 HC (290 HC)	3,73 (6,70)	2,62 (2,53)	2,62 (2,53)	2550 (3800)
24	1	Stapel Aufstiege und Podeste / Bundle of ladders and platforms Faisceau d'échelles et de plates-formes / Serie di scale e rampe Paquete de escaleras y plataformas / Escadas e patamares		120 HC (132 HC)	3,50	1,20	1,00	1000
25	1	Kiste mit Kleinteilen / Crate with small parts Caisse contenant des accessoires / Cassa con accessori Caja con accesorios / Caixa de acessórios			2,00	1,00	1,00	2000

*() **Angaben in Klammern gelten für 8 m-Unterwagen.** / The data in brackets are valid for an undercarriage of 8 m. / Les données techniques indiquées entre parenthèses sont valables pour un châssis de 8 m. / Caratteristiche in (..) valgono per carro di 8 m. / Los datos entre paréntesis son válidos para carro de 8 m. / Características em (..) válidas pelo chassis de 8 m.

121 P – 3603 H1 B3 DIN 15018 • BGL 2125-0112 / FEM (Section 1) Krangruppe A3 • 01.02 / 6

Konstruktionsänderungen vorbehalten! / Subject to alterations!
Sous réserves de modifications! / Si fa riserva di modifiche!
Salvo modificação da construação! / ¡Sujeto a modificaciones!

Printed in Germany.

LIEBHERR-WERK BIBERACH GMBH, Postfach 1663, D-88396 Biberach an der Riß
☎ (0 73 51) 41-0, Fax (0 73 51) 41 22 25, www.lbc.liebherr.de, E-Mail: info@lbc.liebherr.com